

# PRATO

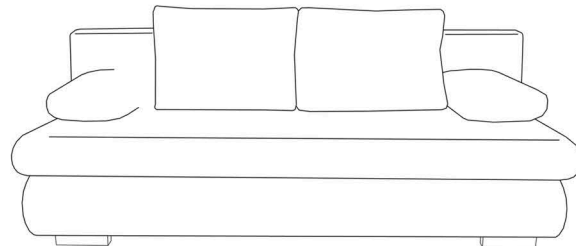

1

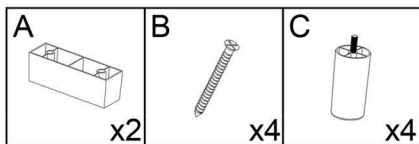
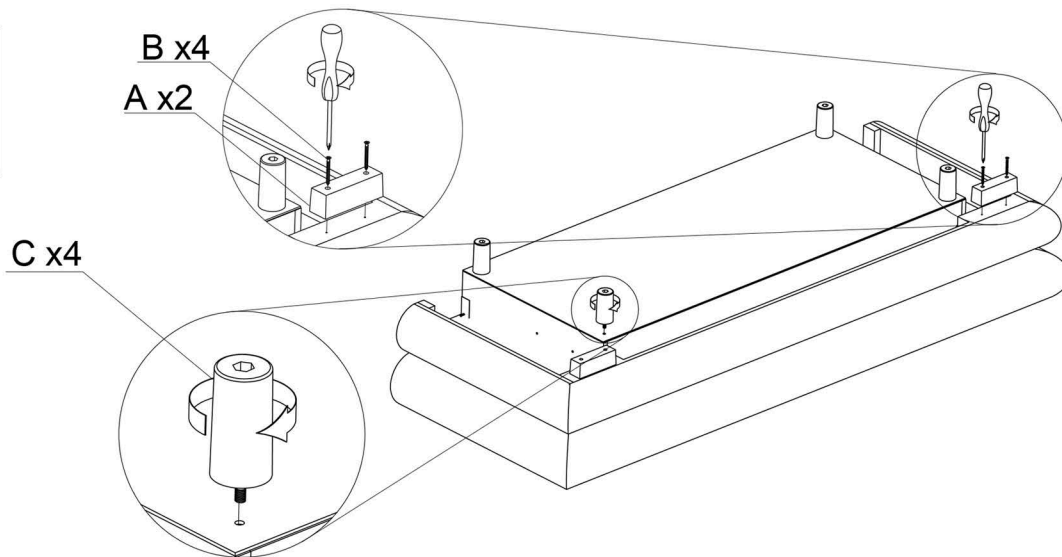

1/2

2

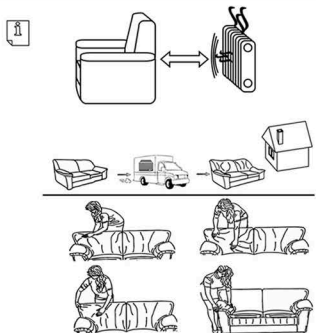
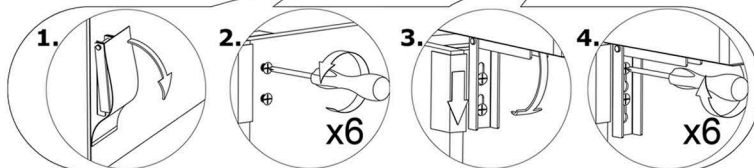
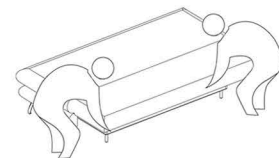
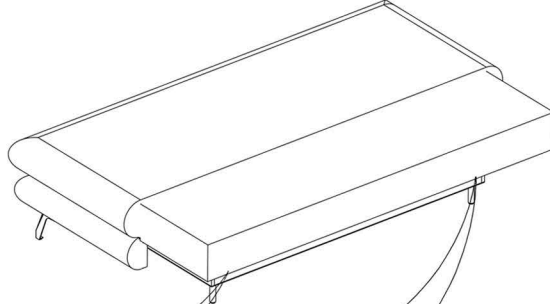

GABI JERCZYŃSKI  
SPÓŁKA KOMANDYTOWA  
Piaski 9a,  
63-645 Łęka Opatowska  
email: gabi@gabi.com.pl  
tel. 62 782 98 00

**PL.** utylizacja produktu : skontaktuj się ze swoim operatorem do spraw gospodarki odpadami **GB.** product disposal: contact your waste management operator **CZ.** likvidace produktu: kontaktujte svého provozovatele odpadového hospodářství **SK.** likvidácia produktu: kontaktujte svojho prevádzkovateľa odpadového hospodárstva **HU.** termék ártalmatlanítása: vegye fel a kapcsolatot a hulladékgyűjtőszolgálatossal **RO.** eliminarea produsului: contactați operatorul dumneavoastră de gestionare a deșeurilor **LT.** gaminio išmetimas: kreipkitės į atliekų tvarkymo operatorių **SI.** odstranjevanje izdelka: obrnite se na izvajalca ravnanja z odpadki **HR.** zbrinjavanje proizvoda: obratite se svom operateru za zbrinjavanje otpada